



GoTime™ Sport/LX Booster Seat

Owner's Manual

Keep instructions for future use.

With Backrest*

18 to 54.4 kg
(40 to 120 lbs)

112 to 145 cm
(44 to 57 in.)

At least 4 years old

Without Backrest*

18 to 54.4 kg
(40 to 120 lbs)

112 to 145 cm
(44 to 57 in.)

At least 4 years old

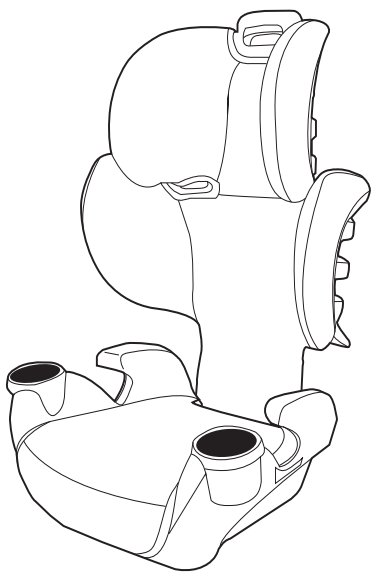

* See page 4 for complete requirements.

WARNING!

To reduce the risk of serious injury or death, read this owner's manual and product warning labels prior to installing and using this Booster Seat.

According to the U.S. National Highway Traffic Safety Administration (NHTSA), car seats and boosters provide protection for infants and children in a crash, yet car crashes are a leading cause of death for children.

To reduce the risk of **SERIOUS INJURY OR DEATH**, read this owner's manual and your vehicle owner's manual before installing and using this Booster Seat. Using a Booster Seat makes a big difference. By properly using this Booster Seat and following these instructions, the instructions on the Booster Seat, and the instructions that accompany your vehicle, you will greatly reduce the risk of serious injury or death to your child from a crash. Do not be misled by the commonly used term "safety seat"; no restraint system can prevent all injuries in all crashes. Many properly restrained adults and children are injured in motor vehicle crashes, including relatively minor crashes. A properly used Booster Seat is the best way to minimize injuries to your child and to increase the chances for your child's survival in most crashes.

U.S. REGULATORY NOTICE

This Booster Seat meets all applicable requirements of Federal Motor Vehicle Safety Standard 213.

CANADIAN REGULATORY NOTICE

(Model numbers ending in "C.")

This Booster Seat meets all applicable requirements of Canada Motor Vehicle Safety Standard CMVSS 213.2.

Table of Contents (TOC)

Important Information

Child Requirements	4
Warnings	5
Recall Information.....	10
Public Notice for Canadian Customers.....	10
Motor Vehicle/Aircraft Usage	11
Booster Seat Features.....	12
Assembling Your Booster Seat	14

Using Your Booster Seat

When to Put Your Child in a Booster Seat	18
Using Your Booster Seat with the Backrest	20
Installation Checklist.....	21
Using Your Booster Seat without the Backrest	22
Installation Checklist.....	23

General Information

Adjusting the Headrest	24
Removing the Backrest	25
Using the Shoulder Belt Clip.....	26
Removing the Seat Pad.....	27
Care and Cleaning.....	28
Replacement Parts	29
Proper Disposal of this Booster Seat.....	29
Storing Your Instructions	30
Limited Warranty.....	31

Child Requirements

⚠ WARNING! DEATH or SERIOUS INJURY can occur.

This Booster Seat is designed for use by children in **booster mode** only. To use this Booster Seat properly, children **MUST** meet the size and age requirements below.

Please review any applicable local, state or provincial laws related to child passenger safety before installing and using this Booster Seat.

With Backrest

- 18 to 54.4 kg (40 to 120 lbs)
- 112 to 145 cm (44 to 57 in.)
- Child is at least four years old
- The tops of the child's ears are below the top of the Booster Seat headrest.



Without Backrest

- 18 to 54.4 kg (40 to 120 lbs)
- 112 to 145 cm (44 to 57 in.)
- Child is at least four years old
- The tops of the child's ears are below the top of the vehicle headrest.



IMPORTANT: Once your child **exceeds** any of the size requirements above, you **MUST** discontinue use of this seat. Your child may be ready for use of the vehicle belt system only at this time.

⚠ WARNING! DEATH or SERIOUS INJURY can occur.

Airbag Warnings



- **DO NOT** use this Booster Seat in the front seat of a vehicle equipped with an active air bag. Air bags may cause serious injury or death to children 12 and under. If your vehicle has an air bag, refer to your vehicle owner's manual for Booster Seat installation.
- If the rear seat of your vehicle is equipped with side air bags, refer to the following information for proper usage:

Vehicles built prior to the 2002 model year: DO NOT use this Booster Seat in a vehicle seating position equipped with a side air bag unless authorized by the vehicle manufacturer.

Model year 2002 and newer vehicles: Refer to your vehicle owner's manual before placing this Booster Seat in a seating position equipped with a side air bag.

- **DO NOT** place any objects between the Booster Seat and the side air bag, as an expanding air bag may cause the items to strike your child.

The forward-facing rear seat is the safest place for children 12 and under.

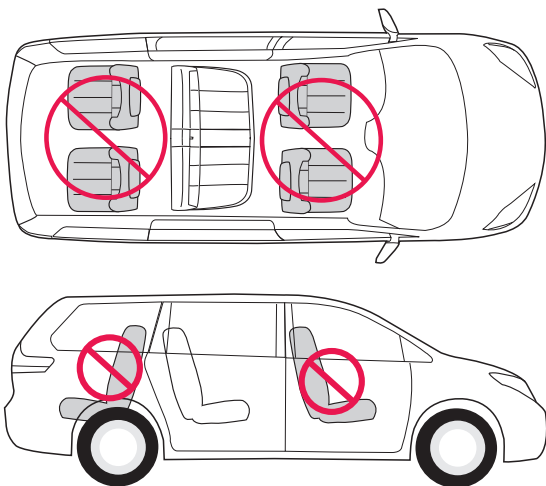

WARNING! DEATH or SERIOUS INJURY can occur.

General Warnings

- Failure to follow each of the following instructions and product warning labels can result in your child striking the vehicle's interior during a sudden stop or crash, potentially resulting in serious injury or death. These instructions and the instructions in your vehicle owner's manual must be followed carefully. If there is a conflict between the two, the vehicle owner's manual regarding Booster Seat installation must be followed.
- **NEVER** leave child unattended.
- In addition to the height and weight requirements, your child must be at least four years old to use this Booster Seat. See page 18 for more guidance.

Location Warnings

- According to statistics, children are safer when properly restrained in a rear seating position than in the front seating position. Children 12 and under should ride in the back seat of the vehicle.
- Use this Booster Seat only on forward facing vehicle seats. **DO NOT** use this Booster Seat with vehicle seats which face the rear or side of the vehicle.
- Use this Booster Seat only on vehicle seats with backs that lock into place.
- Some Booster Seats do not fit in all vehicles. If the Booster Seat cannot be properly installed, **DO NOT** use the Booster Seat. Consult your vehicle owner's manual, try a different seating location, or call Evenflo at 1-937-773-3971 (Canada) or 1-800-233-5921 (US) for further assistance.

Booster Seat Position Warnings

- **DO NOT** use this Booster Seat rear-facing.
- When using this Booster Seat, the headrest on the vehicle seat that the child faces should be put in its lowest position. The vehicle seat back that the child faces must be fully padded and free of any hard objects.

! WARNING! DEATH or SERIOUS INJURY can occur.

Seat Belt Warnings

- **ALWAYS** read your vehicle owner's manual to determine what vehicle belts and retractors are used in your vehicle.
- **DO NOT** use this Booster Seat in a vehicle with door-mounted seat belts.
- **DO NOT** use this Booster Seat in a vehicle with seat belts that automatically move along the vehicle frame when the door is opened. These seat belts will not hold a Booster Seat properly.
- **DO NOT** use with lap/shoulder belts with two retractors. If the vehicle seat belts are not routed and fastened correctly, the Booster Seat may not protect the child in a crash.
- When using this Booster Seat, **NEVER** use a lap belt only. You **MUST** use vehicle seat belts that have a lap/shoulder combination.
- **DO NOT** use this Booster Seat **with the backrest** if the child's ears are above the top of the Booster Seat headrest.
- Failure to adjust the seat belts snugly around your child may result in your child striking the vehicle's interior during a sudden stop or crash.
- **DO NOT** use this Booster Seat if it is damaged or has broken or missing parts.

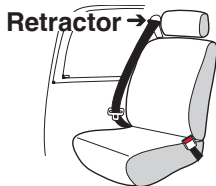

! WARNING! DEATH or SERIOUS INJURY can occur.

Seat Belt Warnings

If you have any of these types of vehicle belt systems listed, these are SAFE to use to install your Booster Seat in the vehicle. Review vehicle owner's manual for specific instructions on Booster Seat installation.

Lap/Shoulder Belt with Locking Latch Plate

The lap portion of this belt does not loosen once the belt is buckled. The vehicle belt is tightened by pulling up hard on shoulder belt and feeding the extra webbing into the retractor.

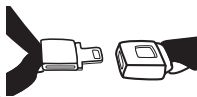

Lap/Shoulder Belt with Sliding Latch Plate with Locking Retractor

The latch plate slides freely along the lap/shoulder belt. Vehicle belts with sliding latch plates are typically locked at the shoulder belt retractor by buckling the belt and pulling all of the webbing out slowly to switch the retractor.

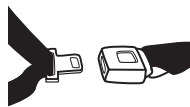

⚠ WARNING! DEATH or SERIOUS INJURY can occur.

Additional Warnings

- **DO NOT** use this Booster Seat if it has been involved in an accident. It must be replaced.
- This Booster Seat must be securely belted to the vehicle at all times. An unsecured Booster Seat may injure someone if a crash occurs.
- **DO NOT** attach additional padding, toys, or other devices not made by Evenflo to the Booster Seat. Items not tested with the Booster Seat could injure the child.
- In hot, sunny weather cover the seat with a light colored blanket when you leave the vehicle. Always check the seat for hot surfaces before putting a child into the seat.
- **DO NOT** use this Booster Seat without the seat pad.

Recall Information

- Child restraints or Booster Seats could be recalled for safety reasons. You must register this Booster Seat to be reached in a recall. Send your name, address, e-mail address if available, and the Booster Seat's model number and manufacturing date to:

Evenflo Company, Inc.,

1801 Commerce Dr.,

Piqua, OH 45356

or call 1-800-233-5921

or register online at

www.evenflo.com/registercarseat

- For recall information, call the U.S. Government's Vehicle Safety Hotline at 1-888-327-4236 (TTY:1-800-424-9153), or go to **<http://www.NHTSA.gov>**

Tear off and mail this part

Consumer: Just fill in your name and address and e-mail address.		
Your Name _____		
Your Street Address _____		
City _____	State _____	Zip Code _____
E-mail Address _____		
CHILD RESTRAINT REGISTRATION CARD		

Public Notice for Canadian Customers

- A recall or notice of defect can be issued for safety reasons. You must register this Booster Seat to be reached in a recall. Send your name, address and the Booster Seat's model number and manufacturing date to:

Evenflo Company, Inc.,

1801 Commerce Dr.,

Piqua, OH 45356

or call 1-937-773-3971

www.evenflo.com/registercarseatcanada

- For recall information, call Transport Canada at 1-800-333-0510 (1-613-993-9851 in Ottawa region) or Evenflo at 1-937-773-3971.

2009187 8/15

CANADIAN RESIDENTS ONLY
DOMICILIÉS DU CANADA SEULEMENT

**PRODUCT REGISTRATION CARD
CARTE D'ENREGISTREMENT DU PRODUIT**

1. Name Nom _____	
2. Street Address Adresse _____	
3. City Ville _____	4. Prov. Prov. _____
5. Postal Code Code postal _____	
6. Telephone Number (with Area Code) Num. de téléphone (et indicatif régional) (____) _____	
7. Email Address Adresse électronique _____	
8. Date of Purchase Date d'achat _____	

ATTENTION: This card may be important to the safety of your child. Please complete using blue or black ink and mail this card so that you can be contacted in the event of a safety defect notice on this product. **The information you provide must be complete.** Or register online at www.evenflo.com/registercarseatcanada.

ATTENTION: Cette carte pourrait être importante à la sécurité de votre enfant. Veuillez remplir cette carte à l'encre bleue ou noire et la poster afin de pouvoir être contacté en cas d'un avis de défaut lié à la sécurité de ce produit. **Les informations fournies doivent être complètes.** Ou enregistrez-vous en ligne à www.evenflo.com/registercarseatcanada.

PLACE DATE/MODEL # LABEL HERE.
AFFRER L'ÉTIQUETTE DE LA DATE ET
DU NUMÉRO DE MODÈLE ICI.

Motor Vehicle/Aircraft Usage



When properly installed pursuant to these instructions, this Booster Seat is certified for use only in passenger and multi-purpose passenger motor vehicles, buses and trucks if they are equipped with lap/shoulder belt systems

This Booster Seat is **NOT** certified for aircraft use. A belt-positioning booster requires the use of a lap/shoulder belt system, which is not available on aircraft.

Booster Seat Features

Front

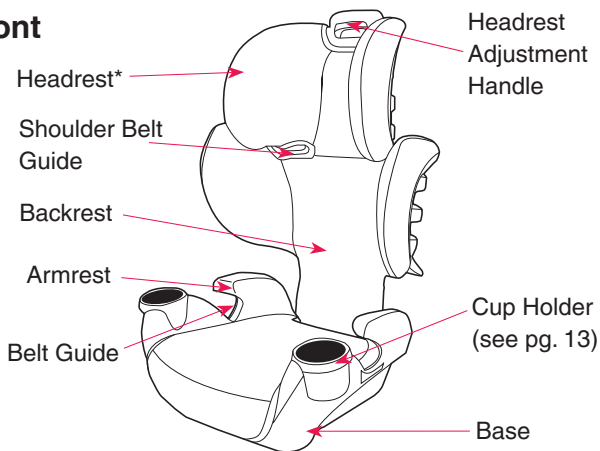

Back

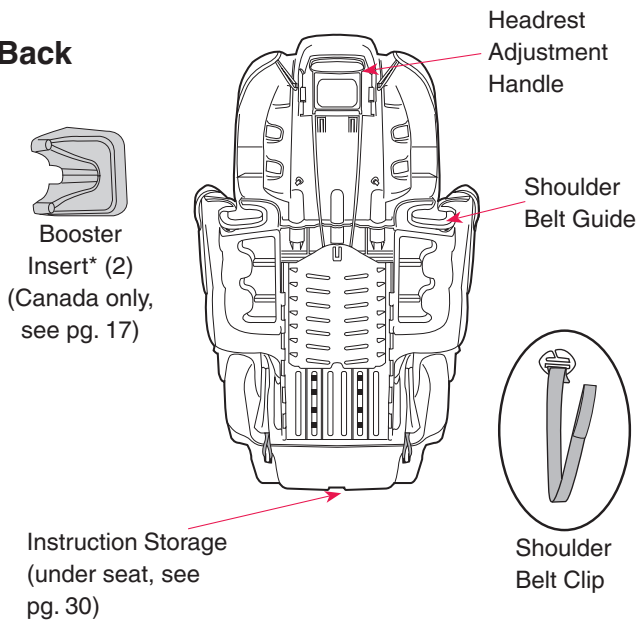

* Not all features are available on all models. Styles may vary.

Booster Seat Features

Using the Cup Holder

⚠ WARNING! DEATH or SERIOUS INJURY can occur.

- **DO NOT** use the cup holder to store cans, bottles, or hard containers. Only for use with soft cups.
- **DO NOT** place any cups that contain hot liquids in the cup holder.

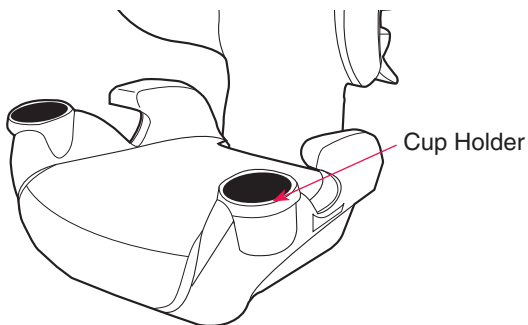

Assembling Your Booster Seat

- 1. Assemble the headrest.** Insert three posts on the headrest into the backrest, as shown. Make certain the headrest clicks securely into the backrest.

Note: This is a one-time assembly and may require additional force to connect properly.

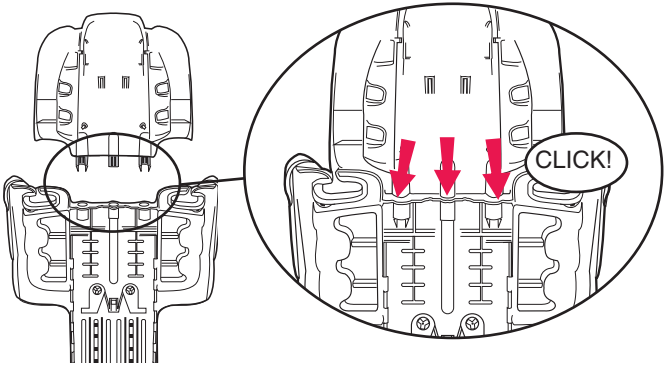

- 2. Install adjustment handle.** Align tabs on adjustment handle with the slots on the back of the headrest. Press adjustment handle against the back of the headrest and slide upward until the tabs click into place.

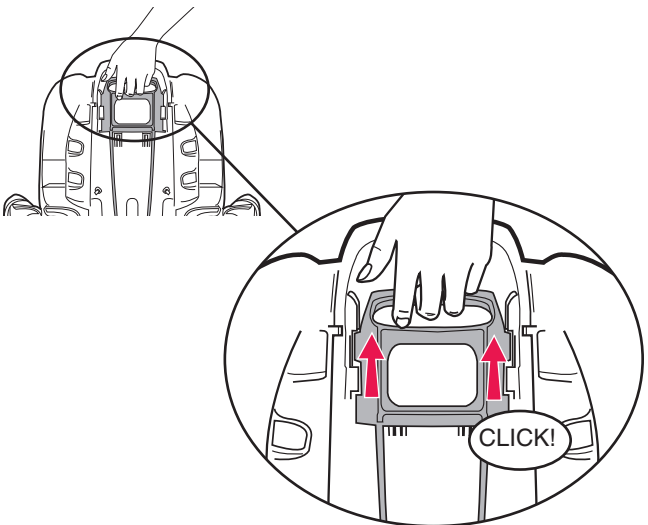

Assembling Your Booster Seat

- 3. Assemble the backrest.** Slide adjustment track into backrest assembly while squeezing handle. Make certain adjustment track can slide freely into different positions.

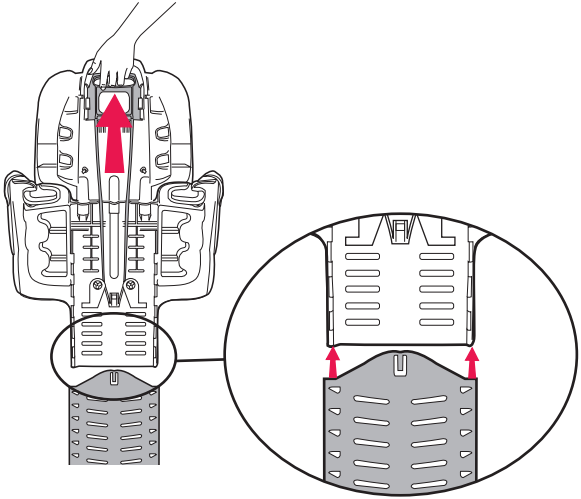

- 4. Attach the seat pad to the backrest assembly.**

Connect four elastic loops to the hooks on headrest followed by the two tabs and six elastic loops to the hooks on the backrest.

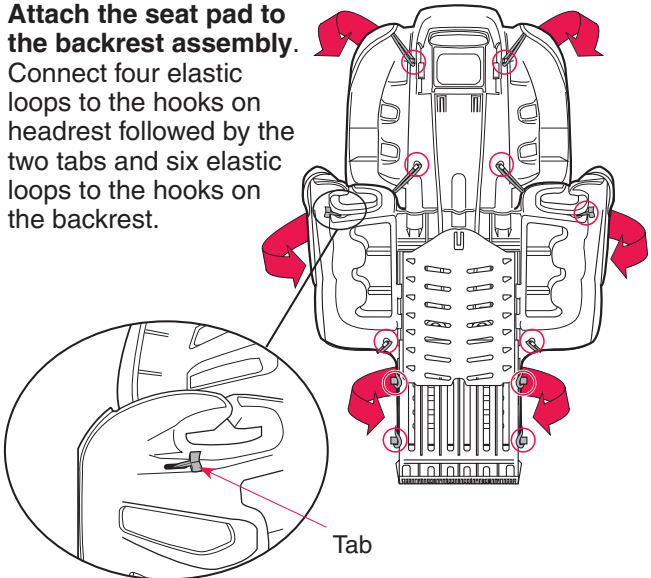

Assembling Your Booster Seat

- 5. Attach the seat pad to the base.** Connect elastic loops to the hooks on the back of the base. Push retainer clips into the corresponding holes in the front of the base and push UP to secure in place.

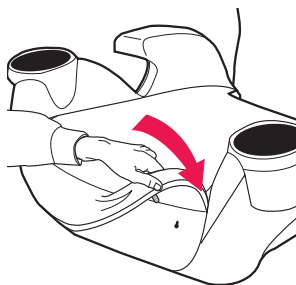

- 6. Install the backrest assembly.** Position the base under the backrest assembly. Slide the backrest assembly onto the base. Make certain the backrest assembly locks into place with an audible click.

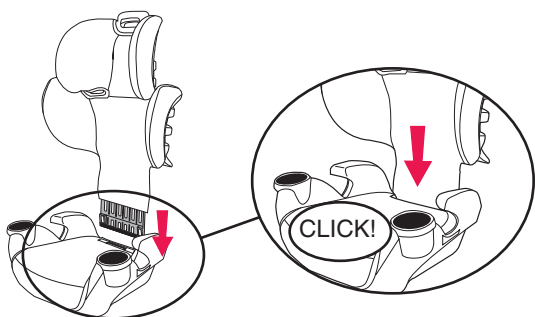

- 7. Check your work.** Inspect the Booster Seat. Pull up on the headrest to make sure it is securely attached to the backrest. Make sure the seat pad is hooked into place. Pull on the backrest to make sure it is securely attached to the base. Repeat any assembly steps as necessary.

Assembling Your Booster Seat

Booster Insert (Canada Only)

FOR CANADIAN MODELS ONLY: The Booster Inserts **MUST** be installed before use of this Booster Seat in a vehicle.

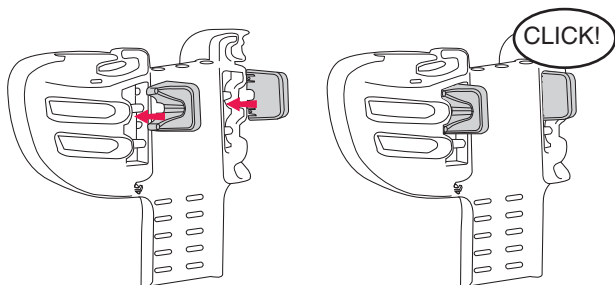

To install the Booster Inserts, line up the tabs to the slots at the rear of the backrest. Slide the Booster Inserts onto the backrest. Make certain the Booster Inserts lock into place with an audible click.

Note: This is a one-time assembly and may require a screwdriver to remove once installed.

When to Put Your Child in a Booster Seat

Booster Seats raise the child up and help to position the vehicle lap and shoulder belt correctly. The Booster Seat itself does not provide the primary means of restraint – the vehicle belts do. When the child is properly restrained in a Booster Seat with the vehicle belts, their risk of injury in all types of crashes is reduced, as the lap and shoulder belt provide excellent restraint of the upper and lower torso.

It is important for the child to sit properly within the vehicle seat belts. When the vehicle belt is buckled, the lap belt should be low on the hips, just touching the thighs, and the shoulder belt should lie across the middle of the shoulder. If the child leans out, moves the belt behind the back, or places it under the arm, it will not provide the intended restraint.

You should consider using a Booster Seat if the following conditions apply:

- The child is approaching/has exceeded the weight or height limit of their Car Seat's forward-facing, harnessed mode of use.
- The child is mature enough to sit in the Booster Seat with the vehicle belts in proper position and not put the belts under their arm or behind their back.
- **For US use only:** If your child meets the requirements for both forward-facing harnessed use and booster use, and your vehicle does not have a Tether Anchorage, but does have lap and shoulder belts in the back seat, a Booster Seat may provide better protection than an internal harness seat without the Tether.

How is a Booster Seat used?

Using a Booster Seat is very similar to buckling yourself into the vehicle because you are using the vehicle's restraint system to secure your child:

- Read the instruction manuals for both the Booster Seat and the vehicle before you start.
- Put the Booster in the back seat in a location with a lap and shoulder belt. **Never use a Booster Seat with only a lap belt, as this could cause serious injuries.**
- Base of Booster should be flat on vehicle seat.
- After the child is in the Booster, pull the lap and shoulder belt across and buckle it. Your child is being restrained by the vehicle's lap and shoulder belt, so fit of the belts are important.
- Check that the shoulder belt lies across the middle of the shoulder and that the lap belt is low on the hips, just touching the thighs.

Using Your Booster Seat with the Backrest

Child Requirements

- **Weight:** 18 – 54.4 kg (40 – 120 lbs)
- **Height:** 112 – 145 cm (44 – 57 inches)
- **Age:** At least four years old
- The tops of the child's ears are below the top of the Booster Seat headrest.

Shoulder Belt: The shoulder belt **MUST** pass through shoulder belt guide and the shoulder belt **MUST** lie across the middle of the shoulder.

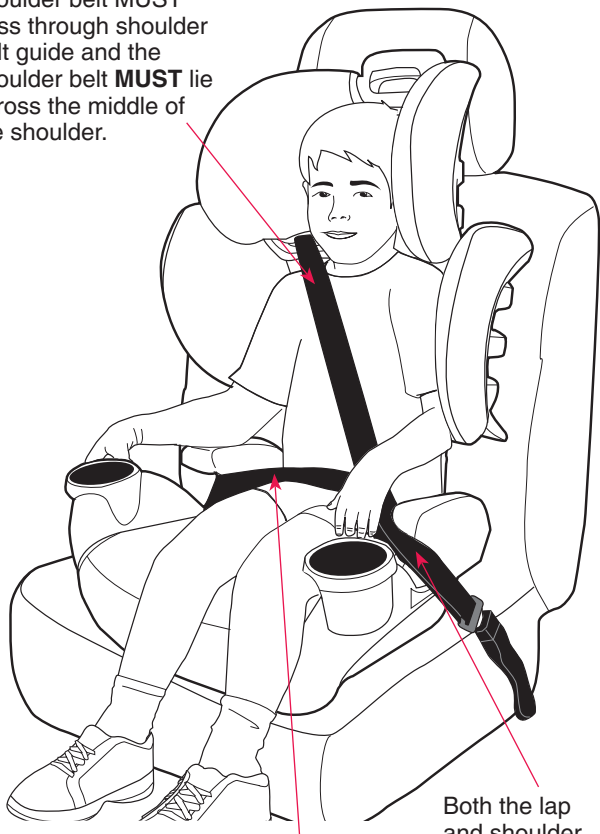

Lap Belt: Stretched low and snug across the child's hips, and fastened into the buckle.

Both the lap and shoulder belts **MUST** be positioned under the armrest on the Booster Seat.

Installation Checklist

1. Place the Booster Seat on the vehicle seat.

2. Set the child in the Booster Seat.

Make sure the child's back and bottom are flat against the back and bottom surfaces of the Booster Seat.

3. Adjust the headrest, if necessary.

Adjust the headrest height so the shoulder belt guides are at or slightly above the top of the child's shoulders. This will cause the shoulder belt to properly lay midway between the child's shoulder and neck (see Adjusting the Headrest, page 24).

⚠ WARNING! DEATH or SERIOUS INJURY can occur.

The shoulder belt **MUST NOT** cross the child's neck or fall off the child's shoulder. If you cannot adjust the shoulder belt to properly lay midway between the child's shoulder and neck, try another seating location or do not use the Booster Seat.



4. Secure the child and Booster Seat to the vehicle seat.

Stretch the lap/shoulder belt across the child and fasten the buckle. Make certain the shoulder belt is threaded through the shoulder belt guide. Both the lap and shoulder belts **MUST** be positioned under the armrest on the Booster Seat.

5. Check your work.

Make sure the lap belt is stretched low and snug across the child's hips, and fastened into the buckle. The shoulder belt must cross the child midway between his/her shoulder and neck.

IMPORTANT: Always secure the Booster Seat with the vehicle seat belts when not occupied. An unsecured Booster Seat can fly into and injure other occupants in the event of a crash.

Using Your Booster Seat without the Backrest

Child Requirements

- **Weight:** 18 – 54.4 kg (40 – 120 lbs)
- **Height:** 112 – 145 cm (44 – 57 inches)
- **Age:** At least four years old
- The tops of the child's ears are below the top of the vehicle headrest.

Shoulder Belt: Must cross midway between child's shoulder and neck. Use shoulder belt clip, if necessary.

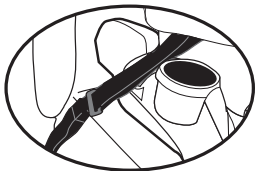

Both the lap and shoulder belts **MUST** be positioned under the armrest on the Booster Seat.

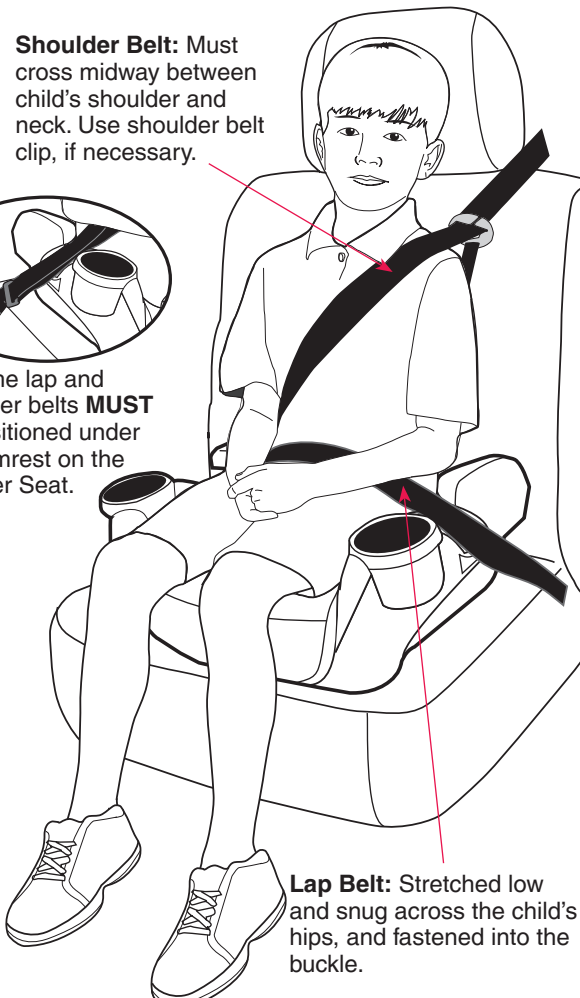

Lap Belt: Stretched low and snug across the child's hips, and fastened into the buckle.

Installation Checklist

1. Remove the backrest from the Booster Seat.

(See Removing the Backrest, page 25.)

2. Place the Booster Seat on the vehicle seat.

3. Set the child in the Booster Seat.

Make sure the child's back is flat against the vehicle seat, and the child's bottom is flat against the Booster Seat.

4. Secure the child and Booster Seat to the vehicle seat.

Stretch the lap/shoulder belt across the child and fasten the buckle. Both the lap and shoulder belts **MUST** be positioned under the armrest on the Booster Seat.

5. Use the shoulder belt clip, if necessary.

If the shoulder belt does not properly lay midway between the child's shoulder and neck, attach and adjust the belt clip (see Using the Shoulder Belt Clip, page 26).

⚠ WARNING! DEATH or SERIOUS INJURY can occur.

The shoulder belt **MUST NOT** cross the child's neck or fall off the child's shoulder. If you cannot adjust the shoulder belt to properly lay midway between the child's shoulder and neck, try another seating location or do not use the Booster Seat.



6. Check your work.

Make sure the lap belt is stretched low and snug across the child's hips, and fastened into the buckle. The shoulder belt must cross the child midway between his/her shoulder and neck.

Note: If the vehicle's shoulder belt naturally crosses the child's shoulder, you do not need to use the shoulder belt clip.

IMPORTANT: Always secure the Booster Seat with the vehicle seat belts when not occupied. An unsecured Booster Seat can fly into and injure other occupants in the event of a crash.

Adjusting the Headrest

You will need to adjust the headrest as your child grows to maintain proper seat belt positioning.

To adjust the headrest, pull and hold the adjustment handle then slide the headrest up or down. The headrest is positioned properly when the shoulder belt guides are at or slightly above the top of child's shoulders.

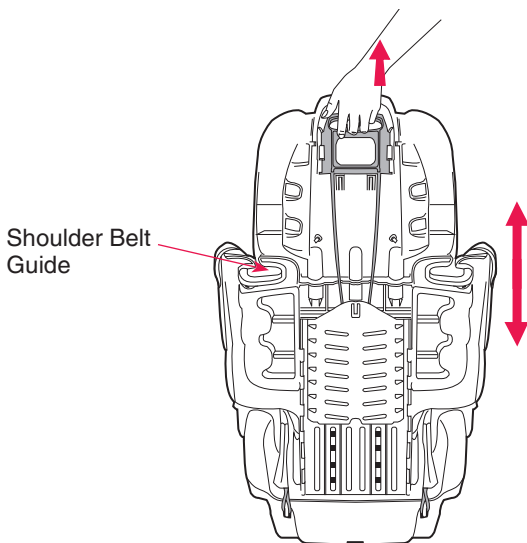

Removing the Backrest

1. Lay the Booster Seat on its front.
2. Pull lever on the bottom of the base and remove the backrest from the base.

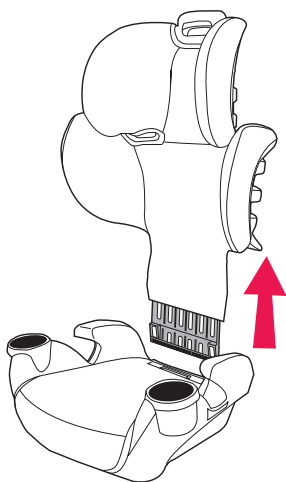
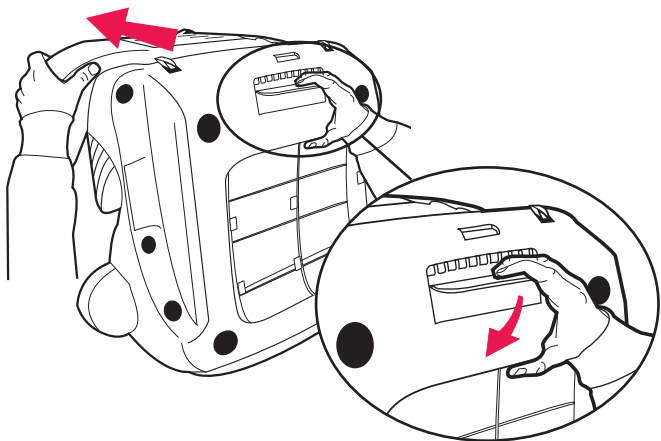

Important: Store the backrest properly when not in use.

Using the Shoulder Belt Clip

Note: Use the Shoulder Belt Clip only when necessary to position the shoulder belt so it lays across the child's chest midway between his/her shoulder and neck.

1. Thread the looped end of the shoulder belt clip belt through the anchor point on back of the base.
2. Thread the shoulder belt clip through the loop at the end of the belt and pull until tight.

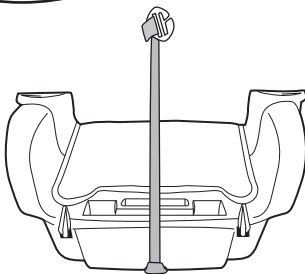
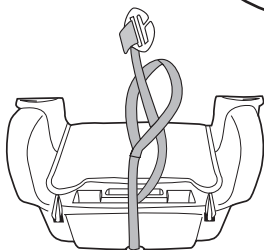
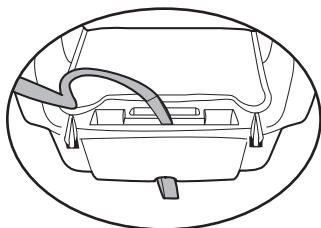

3. Place booster on the vehicle seat and attach the shoulder belt clip to the vehicle shoulder belt.
4. Pull the adjustment strap until belt clip is at or slightly above the child's shoulder and the vehicle shoulder belt lays across the child's chest midway between his/her shoulder and neck.

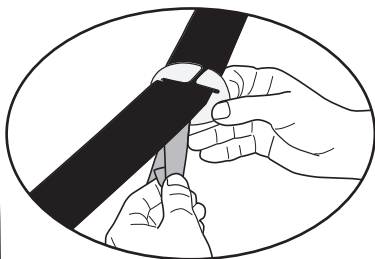

Removing the Seat Pad

- 1. Remove the seat pad from the backrest assembly.** Disconnect elastic loops from the hooks on the backrest assembly. Remove the seat pad.

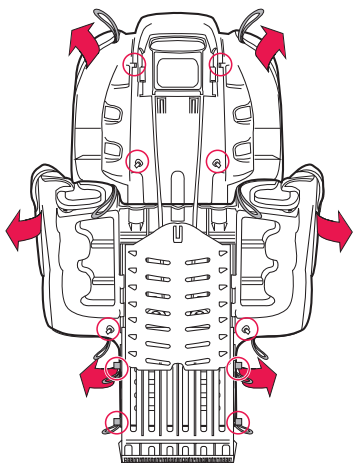

- 2. Remove the seat pad from the base.** Disconnect elastic loops from the hooks on the back of the base. Pull DOWN on the retainer clips and disconnect clips from the front of the base. Remove the seat pad.

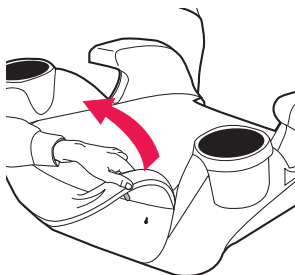

Care and Cleaning

- Plastic parts may be wiped clean with mild soap and water and dried with a soft cloth. Do not use abrasive cleaners or solvents.
- Take care not to damage any labels.
- The seat pad (except for leather seat pads*) can be machine washed separately in cold water, delicate cycle, tumble dry 10 to 15 minutes on low heat.
- **NEVER** use Booster Seat without the seat pad.
- To protect the Booster Seat from damage caused by weather, rodents, and other elements common to garages, the outdoors, and other storage locations, remove the seat pad and thoroughly clean the Booster Seat and pad prior to storage. Take care to clean in the areas where crumbs and other debris tend to accumulate.

TIP: To help protect the vehicle upholstery, place a towel beneath and behind the Booster Seat.

Replacement Parts

You can order replacement parts online at www.evenflo.com or by contacting Evenflo ParentLink. When you contact us, please have the product model number and date of manufacture (found on the bottom of the Booster Seat).

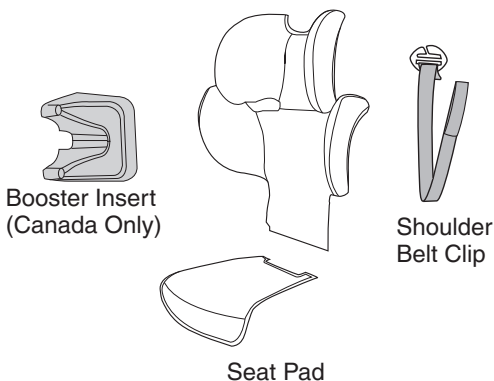

* Not all features are available on all models. Styles may vary.

Proper Disposal of this Booster Seat

When this Booster Seat reaches the expiration date found on the date of manufacture label, Evenflo encourages you to dispose of it properly. Most components of this Booster Seat are recyclable.

1. Remove all fabric and padding.
2. Remove all screws and disassemble the Booster Seat.
3. Recycle all fabric, padding, plastic, foam and metal parts, if accepted by your local recycling center. Responsibly discard the rest.

If your local recycling center won't accept the padding, you may dispose of it in the landfill.

To prevent injury due to hidden damage, lost instructions, outdated technology, etc., discontinue use of this Booster Seat after the expiration date on the label or if it has been involved in a crash.

Storing Your Instructions

After thoroughly reading and following these instructions, **STORE THE INSTRUCTIONS IN THE SLOTS PROVIDED ON THE BOTTOM OF THE BOOSTER SEAT.**

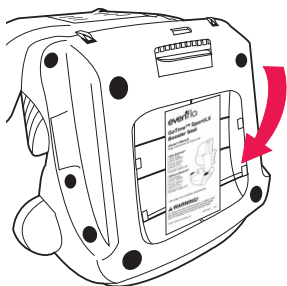

For future reference, record the model number of your Booster Seat AND the date of manufacture below (found on the bottom of the Booster Seat).

MODEL NUMBER _____

DATE OF MANUFACTURE _____

Limited Warranty

For a period of 90 days from the original purchase of this Product, Evenflo warrants to the original end user ("Purchaser") this Product (including any accessories) against defects in material or workmanship. Evenflo's sole obligation under this express limited warranty shall be, at Evenflo's option, to repair or replace any Product that is determined to be defective by Evenflo and determined to be covered by this warranty.

Repair or replacement as provided under this warranty is the exclusive remedy of the Purchaser. Proof of purchase in the form of a receipted invoice or bill of sale evidencing that the Product is within the warranty period must be presented to obtain warranty service. This express limited warranty is extended by Evenflo ONLY to the original Purchaser of the Product and is not assignable or transferable to subsequent purchasers or end users of the Product. For warranty service, contact Evenflo's ParentLink Consumer Resource Center at www.evenflo.com.

EXCEPT TO THE EXTENT PROHIBITED BY APPLICABLE LAW, ANY IMPLIED WARRANTY OF MERCHANTABILITY OR FITNESS FOR A PARTICULAR PURPOSE ON THIS PRODUCT IS HEREBY DISCLAIMED. EVENFLO SHALL NOT BE LIABLE FOR ANY INCIDENTAL, CONSEQUENTIAL, SPECIAL OR PUNITIVE DAMAGES OF ANY KIND FOR BREACH OF THE EXPRESS LIMITED WARRANTY ON THIS PRODUCT, OR ANY WARRANTY IMPLIED BY OPERATION OF LAW. OTHER THAN THE EXPRESS LIMITED WARRANTY SET FORTH ABOVE, THERE ARE NO OTHER WARRANTIES THAT ACCOMPANY THIS PRODUCT AND ANY ORAL, WRITTEN OR ANY OTHER EXPRESS REPRESENTATION OF ANY KIND IS HEREBY DISCLAIMED.

ParentLink®

answers. advice. affirmation.™

- www.evenflo.com
- USA: 1-800-233-5921 8 AM to 5 PM E.T.
- Canada: 1-937-773-3971
- México: 800-706-1200

ParentLink®

answers. advice. affirmation.™

- **www.eventflo.com**
- USA: 1-800-233-5921 8 AM to 5 PM E.T.
- Canada: 1-937-773-3971
- México: 800-706-1200